



# Long-Term Care Low Profile Bed

Model 52300

## User Manual



**DEALERS:** This manual **MUST** be given to the user of the bed.

**USER:** Before using the bed, read this manual and save for future reference.

Copyright ©2021 Emerald Supply, Inc. All rights reserved. Publisher reserves the right to make dimension or specification changes, or deletions, consistent with design trends, product improvements, or for reasons beyond our control. Publisher makes no warranties with respect to the accuracy or completeness of the contents of this manual.



# Table of Contents

<b>GENERAL INFORMATION.....</b>	<b>3</b>
STANDARD SYMBOLS AND WARNING LABELS .....	3
INTENDED USE .....	4
SAFETY PRECAUTIONS.....	4
<b>TECHNICAL SPECIFICATION.....</b>	<b>10</b>
<b>EQUIPMENT ASSEMBLY .....</b>	<b>11</b>
UNPACKING THE BED.....	11
ASSEMBLING THE BED.....	12
<b>EQUIPMENT OPERATION .....</b>	<b>17</b>
POSITIONING THE BED .....	17
EXTEND THE LENGTH OF THE BED FROM 80" TO 88" .....	18
EXTEND THE WIDTH OF THE BED FROM 35" TO 42" OR 48" .....	19
USING THE CONTROLLER .....	20
RESETTING THE BED .....	20
OPERATING THE BED RAILS.....	21
<b>TROUBLESHOOTING GUIDE .....</b>	<b>22</b>
<b>LIMITED WARRANTY .....</b>	<b>23</b>
<b>APPENDIX – SERVICE RECORD .....</b>	<b>24</b>

# GENERAL INFORMATION

## Standard Symbols and Warning Labels

### Warnings

Signal words with symbols are used in this manual to highlight hazards or unsafe practices which could result in personal injury or property damage. See the information below for definitions of the signal words and symbols.



#### **DANGER**

Danger indicates an imminently hazardous situation which, if not avoided, will result in death or serious injury.



#### **WARNING**

Warning indicates a potentially hazardous situation which, if not avoided, could result in death or serious injury.



#### **CAUTION**

Caution indicates a potentially hazardous situation which, if not avoided, may result in property damage or minor injury or both.



#### **IMPORTANT**

Indicates a hazardous situation that could result in damage to equipment or property if it is not avoided.



Gives useful tips, recommendations and information for ease of use.

## Intended Use

The Oasis Long-Term Care Low Profile Bed is intended for use within an institutional healthcare environment, i.e. nursing homes, rehabilitation care, assisted living.

The bed is NOT a transport device. The wheels on the bed are for positioning the bed only. These shall be locked at all times when carrying a patient.

The beds are intended for users who fully understand the content of this manual and is not intended for use by children.

## Safety Precautions

### Assembling the Bed



#### **WARNING**

Make sure all attaching hardware is securely tightened.

DO NOT overtighten the mounting hardware as this will damage the mounting brackets.

DO NOT modify this equipment without authorization of the manufacturer. Doing so will void the warranty.

DO NOT use accessories that are not designed or approved for use with the bed.

### Operating the Bed



#### **WARNING**

DO NOT operate your bed until it is fully assembled and checked.

DO NOT exceed maximum weight limitations of the bed.

ALWAYS make sure the power cable is clear of any moving parts of the bed before switching on the power.

ALWAYS keep hands and fingers away from moving parts to avoid injury.

ONLY use appropriate mattresses and ALWAYS adjust the mattress retainer system accordingly to ensure the mattress is fixed in place.

The mattress must be properly sized to meet entrapment zone dimensional guidelines published by the FDA.

The mattress platform shall be kept in a flat position if the patient's condition could lead to patient entrapment.

ALWAYS keep the bed at the lowest position when the patient is unattended.

Never permit anyone under the bed at any time.

Only permit one person on the bed at a time.

Do not use side rails as handles to move the bed.

The side rails may NOT be used as a restraint.

When operating/moving the bed, ensure that the resident is positioned properly within the confines of the bed. DO NOT let any extremities protrude over the side or between the rails when performing these functions.

Keep all moving parts free from obstruction (i.e. blankets/sheets, pads, tubing, etc.) which may get tangled around the bed, side rails, or legs.

Weight capacity includes the total weight of the mattress, resident, bedding, head and foot boards, side rails, and any accessories. Weight should be evenly distributed.

Do not use near explosive gases.

Possible fire hazard when used with oxygen administering equipment other than nasal or masked type.

When using nasal or masked type administering equipment, oxygen or air tubing MUST be routed and secured properly to ensure tubing does not become entangled, kinked, or severed during normal operation of the bed.

The Central Lock provides the resident with a stable and secure bed, providing easy access in and out of the bed. Check that the Central Lock is engaged and the bed is solidly in place before leaving the bed unattended or before attempting resident transfers into or out of the bed

The Central Lock is not intended to be used on a sloping floor or building access ramp. Failure to comply could result in injury or death.

The Central Lock should be locked at all times except when moving the bed.

For maximum resident safety, casters should be locked at all times in addition to the Central Locking System, except when moving the bed.

## Performing Maintenance



### **WARNING**

ONLY qualified personnel should carry out the bed maintenance.

DO NOT attempt to open the pre-sealed actuator or obtain local service, for it will VOID the warranty and might result in damage. Consult your dealer or manufacturer for further information.

Inspect the casters every six months to check for tightness and wear.

Regular maintenance of bed and accessories is necessary to ensure proper operation. DO NOT overtighten mounting hardware. This will damage mounting brackets.

Unplug the power cord when performing any maintenance on the bed.

## Electrical and Earthing



### **WARNING**

#### **EARTHING**

DO NOT, under any circumstances, cut or remove the earthing prong from any plug. Some devices are equipped with three-prong (earthing) plugs for protection against possible shock hazards. Where a two-prong wall receptacle is encountered, it is the personal responsibility and obligation of the customer to contact a qualified electrician and have the two-prong receptacle replaced with a properly earthed

three-prong wall receptacle in accordance with the regional and national regulations. If you must use an extension cable, use ONLY a three-wire extension cable having the same or higher electrical rating as the device being connected.

DO NOT use if the power cable is cut, frayed or loosely connected to the device. Power supply cable may be damaged by inappropriate handling, e.g. by kinking, shearing or other mechanical damages. The POWER SUPPLY CABLE is only replaceable by SERVICE PERSONNEL.

## Disposal



### **WARNING**

This product has been supplied from an environmentally aware manufacturer.

Where backup battery is used, DO NOT dispose of batteries in normal household waste. They MUST be taken to a proper disposal site. Contact your local waste management company for information.

This product may contain substances that could be harmful to the environment if disposed of in places (landfills) that are not appropriate according to legislation.

Please be environmentally responsible and recycle this product through your recycling facility at its end of life.

## Radio Frequency Interference



### **WARNING**

Most electronic equipment is influenced by Radio Frequency Interference (RFI). CAUTION should be exercised with regard to the use of portable communication equipment in the area around such equipment. If RFI causes erratic behavior, switch the power OFF IMMEDIATELY. DO NOT turn the Power Switch ON while transmission is in progress.



## Reducing the Risk of Entrapment



### **WARNING**

The Hospital Bed Safety Workgroup (HBSW) in partnership with the FDA has recognized potential entrapment zones in hospital bed systems and has developed dimensional guidance to reduce the risk of entrapment. They have identified seven zones in the bed system where there is a potential for patient entrapment. Entrapment may occur in flat or articulated bed positions, with the rails fully raised or in intermediate positions. Each facility is responsible for compliance with the entrapment guidelines. For more information about entrapment zones and guidelines please visit the FDA website.

### ENTRAPMENT ZONES:

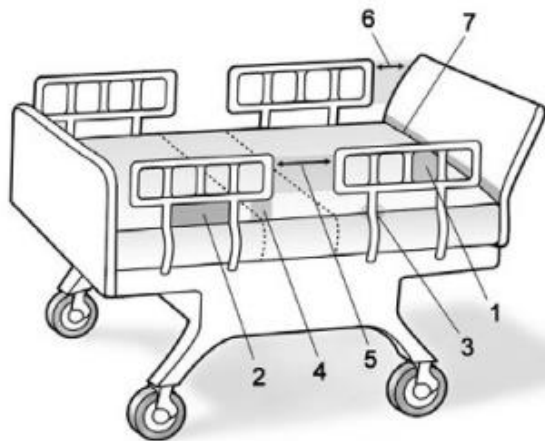

Zone 1: Within the rail

Zone 2: Between the top of the compressed mattress and the bottom of the rail, between the rail supports

Zone 3: Between the rail and the mattress

Zone 4: Between the top of the compressed mattress and the bottom of the rail, at the end of the rail.

Zone 5: Between the split bed rails

Zone 6: Between the end of the rail and the side edge of the head or foot board

Zone 7: Between the head or foot board and the mattress end

## STEPS TO PREVENT BED FIRES

- Inspect the bed's power cord for damage.
- Connect the power cord directly into a wall-mounted outlet that is in good working order, with no cracks or chips. The plug should fit tightly into the outlet. The ground pin should be intact and secure.
- Do not connect the bed's power cord to an extension cord or to a multiple-outlet strip.
- Do not cover any power cord with a rug. Heat may build up or the cord may be damaged.
- Inspect the floor beneath the bed for buildup of dust and lint. Ask housekeeping to clean if necessary.
- Inspect the resident's bed controls, looking for signs of damage where liquids could leak in.
- Test the bed and its controls, including resident lockout features, to ensure that the bed can move freely in both directions without damaging any cords.
- Check monitors and other resident equipment for signs of overheating or physical damage.
- Keep linens and clothes away from power sources.
- Tell maintenance staff about any unusual sounds, burning odors, or unusual movement of a bed.
- If you suspect overheating, follow your facility's policy for fire safety and move resident to a safe area if necessary.

# TECHNICAL SPECIFICATION

Model 52300		
OPERATING RANGE	Bed Height	7.8" – 30"
	Back Rest Angle	0° - 65°
	Knee Break Angle	0° - 35°
	Additional Manual Leg Lift	N/A
	Trendelenburg / Reverse Trendelenburg	N/A
WEIGHT LIMIT	Safe Working Load (SWL)	550 lbs
	Max. Patient Weight	500 lbs
WEIGHTS & DIMENSIONS	Sleeping Surface Dimension Width x Length	35"-42"-48" x 80"-88"
	Caster Size	3"
	Weight IN Carton	307 lbs
	Weight OUT of Carton	268 lbs
ELECTRICS	Power Supply (V/PH/Hz)	100-240V/1ph/50-60Hz
	Power Consumption (Max)	276 W
	Number of Motors	3
	Protection Class	IPX4
	Insulation Class	II Type B
	Duty Cycle	Interruption 10%, Max. 2 min./18min.
Battery backup	N/A	
ENVIRONMENT	Operating Temperature	40°F - 105°F (5°C - 40°C)
	Storage Temperature	15°F – 120°F (-10°C - 50°C)
	Operation & Storage Humidity	20% - 80%
	Operation & Storage Atmospheric Pressure	700 - 1060 hPa
	Operation & Storage Altitude	≤ 3000 m
	Noise Level	< 50 db(a)

# EQUIPMENT ASSEMBLY

## Unpacking the Bed



### WARNING

To avoid injury, DO NOT attempt to remove the bed from the carton without assistance.

- I. Unpack the components from the shipping cartons.
- II. Upon unpacking your bed, the package should contain all of the following components.
- III. Examine exterior of the bed components for nicks, dents, scratches or damages.

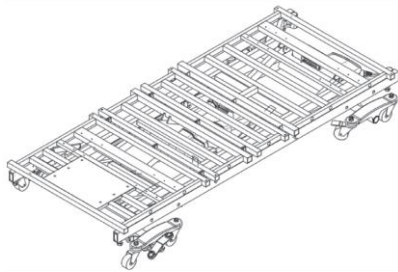

Bed Assembly x 1

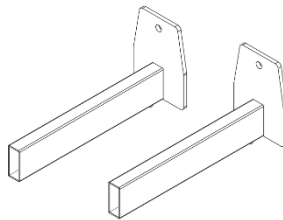

Head/footboard Frame x  
4

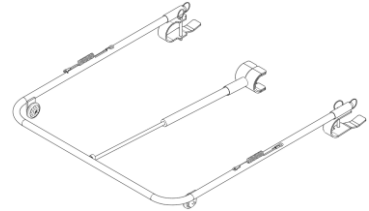

Wall Bumper Bar Assembly  
x 1

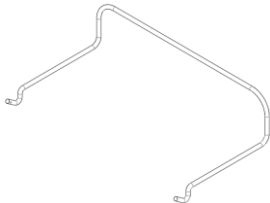

Bed-end Mattress Retainer x 2

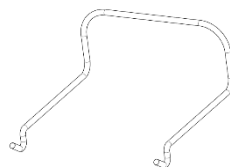

Mattress Retainer x 4



### IMPORTANT

Store the packaged bed in a dry area. Do not place other objects on top of the packaged bed.



Unless the bed is to be used immediately, retain boxes, containers, and packing materials for use in storing until use of bed is required.

## Assembling the Bed

### Assembling the head/foot board brackets to the bed

1. With the bed raised to its highest position, step on the locking levers to lock the casters on at the foot end of the bed.
2. Turn and loosen the two black turn knobs on the underside of the bed assembly insertion slots on the head side of the bed.
3. Slide and push the headboard brackets all the way into the slots. Tighten the black knob to secure the brackets in place.
4. Repeat the same procedure for the footboard bracket installation.

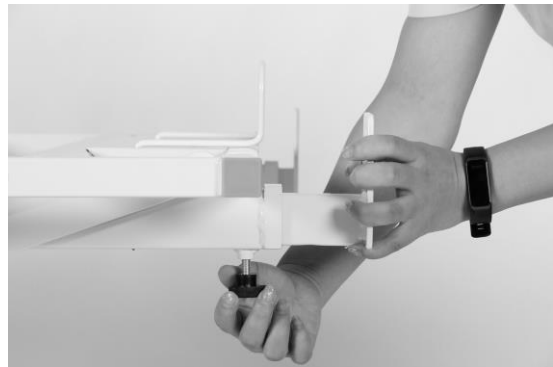
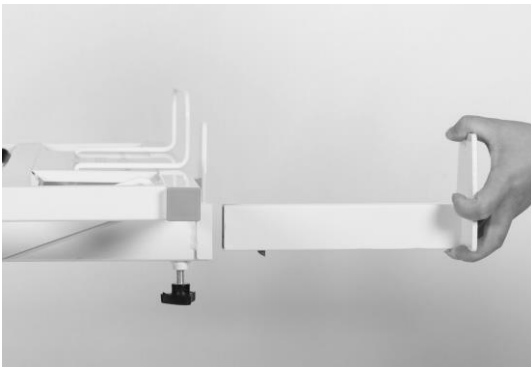

### Assembling the head/foot board

1. With the mounting plates on the headboard facing the bed, slide the mounting plate groove onto the headboard mounting bracket's vertical support.
2. Insert the lock pin through the mounting plate into the headboard to secure the headboard in place. Repeat on the other mounting plate.
3. Repeat the same procedure for footboard installation.

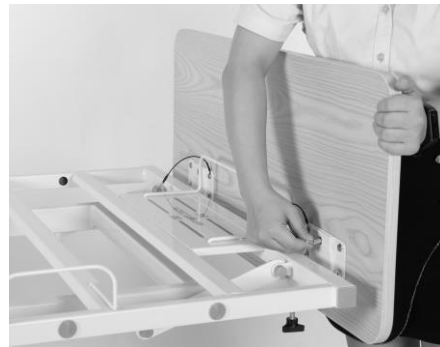

## Installing the mattress retaining system

1. Locate the mounting holes for the mattress retainers in the bed deck. Align and insert the mattress retaining wires through the pre-cast holes.
2. Repeat the procedure for all four side mattress retainers.

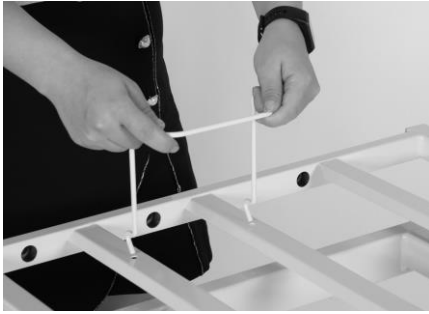

3. Insert the bed end mattress retainer in the foot side of the bed deck through the precast holes.
4. Ensure that all mattress retainers are flat against the bed deck.

Certain bed models have multiple sets of holes for various bed widths and lengths. Adjust the mounting position accordingly for different sized mattresses. The mounting holes are labeled with the corresponding size. Ensure the mattress fits snugly within the mattress retainers.

## Installing the wall bumper bar

1. Raise the bed to its highest position and lock the bed in place.
2. With the wheels of the bumper bar facing down, hook the bar around the head-end caster leg. Insert the pins to secure the bar in place.



3. Connect the bracket on to the black end of the pneumatic cylinder.



4. Insert the other end of the pneumatic cylinder into the socket located in the middle of the bumper bar. Compress the cylinder and hook the bracket on to the center of the caster leg. Release the cylinder.



## Installing the rails or assist bars

1. Before installing the rails or bars, the bed should be in a flat position.
2. Unclip the metal snap ring and remove the metal pins from the mounting brackets.

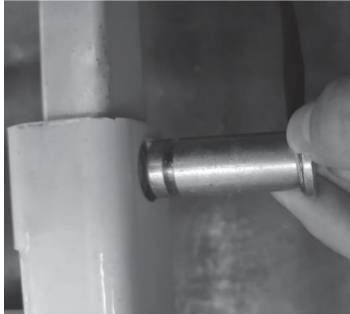

3. Remove cover for the appropriate holes.
4. Slide the U-shaped insert into the assist bar bracket. Place the rail bracket onto the edge of the bed decking. Align the rail bracket mounting holes with the bed deck mounting holes.

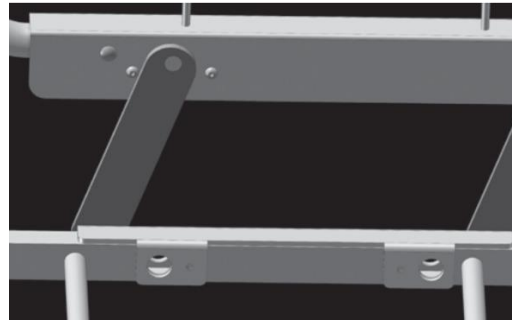
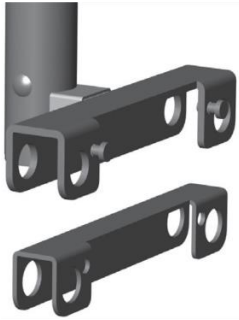

5. Re-insert the metal pins from the outside edge of the bed through the mounting holes and secure with snap rings on the inside edge of the bed. Make sure the snap rings are positioned in the groove of the metal pins.



6. If the bed rail or bar has additional Allen screws, tighten the Allen screws next to the metal pins.
7. Repeat the same procedure to install the other rail.



## Control box connections

Upon opening the control box, each motor connection port is color coded for ease of identification.



DC. Battery Backup Port

1. Backrest Motor
2. Knee-break Motor
3. Hi-Lo Motor
4. Spare
5. Hand pendant or staff control

**DC 1 2 3 4 5**

## Installing battery backup

1. Switch the power supply off when installing the backup battery.
2. Affix the backup battery with nuts and bolts to the side of the control box, on the same holding plate.

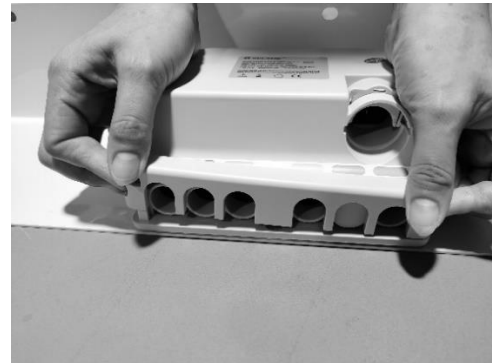
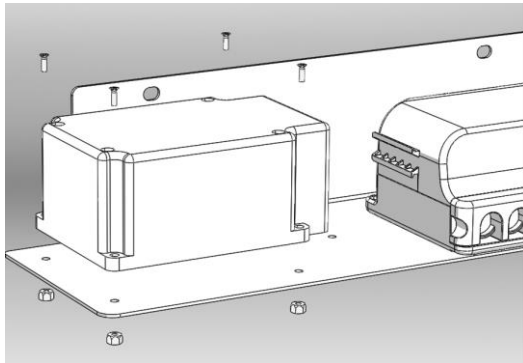

3. Open the control box locking lid by pressing in the sides and lift it up, to expose the connection ports.
4. Connect the backup battery cord to the control box. The connection port is indicated with a battery symbol above.
5. Close the locking lid, there should be an audible click, switch the power supply back on.

# EQUIPMENT OPERATION

## Positioning the Bed

1. To lock the bed, step on the red lever at the rear of the bed.



2. The caster guides on both sides of the head end casters should be lowered to prevent sideways movements. When lowered, the caster guide should hug around the caster.



3. To unlock the casters, step on the green lever at the rear of the bed. Lift up the caster guides on the head end casters to allow free movement.

**NOTE:** Head end caster must be unlocked when raising and lowering the bed. Head end caster guide should be lowered onto the caster when bed is in use.

## Extend the Length of the Bed from 80" to 88"

The bed length can be extended by 2" on either end of the bed. To extend the bed length:

1. Loosen the two black knobs located on the underside of the bed frame securing the head/foot board brackets. (Refer to Section 3)
2. Pull the head/foot board brackets away from the bed squarely with both hands until the brackets latch onto the bed frame. The distance is also marked on the brackets. Tighten the securing knobs once the brackets are extended.
3. Adjust the bed end mattress retention frame to the required position. The extension length is marked on the bed platform.



## Extend the Width of the Bed from 35" to 42" or 48"

1. Under each deck section there are two springed plungers. Pulled down the springed plungers and at the same time slide out the extension piece to the required length. There should be an audible click indicating that the extension piece is locked in place.



2. Repeat the same procedure on all bed sections and on both sides of the bed.
3. Adjust the mattress retainers accordingly.
4. To extend the headboard, lift up and flip the extension piece on the back of the headboard. Reinsert the steel plates into the mounting brackets on the main headboard.



## Using the Controller

The UP arrow ( ▲ ) indicates raising the corresponding parts of the bed.

The DOWN arrow ( ▼ ) indicates lowering the corresponding parts of the bed.

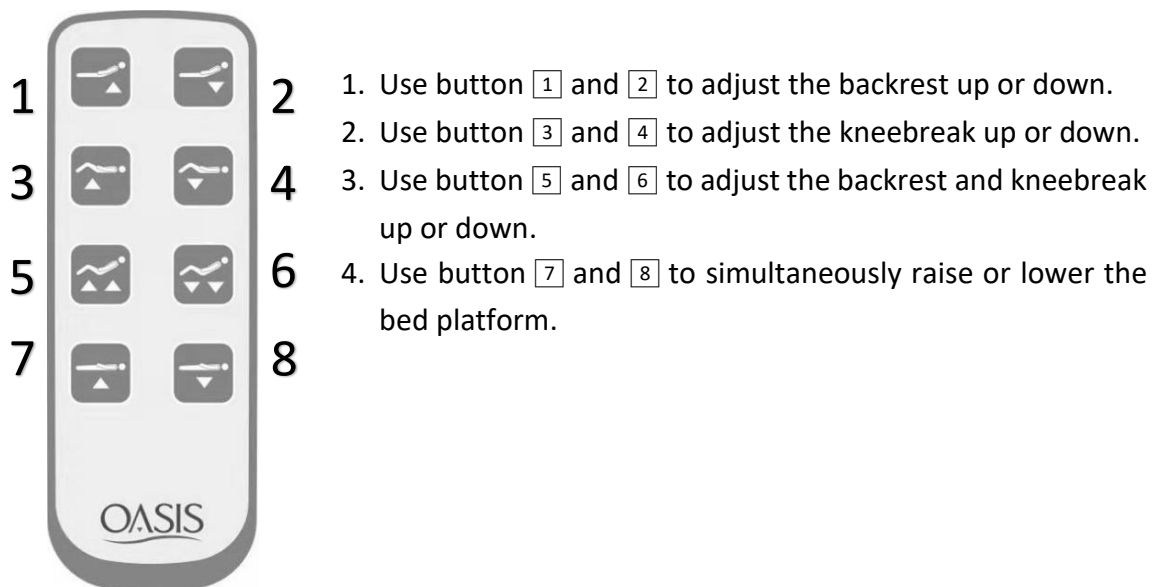

## Resetting the Bed

Where a connection fault is identified and rectified, the control system will require a reset in order to operate again.

1. Press and hold the control button for lowering the backrest and kneebreak. Continue to hold down the button for 10 seconds after the mattress platform is completely flat.



2. Press and hold the control button for raising the mattress platform. Continue to hold down the button for 10 seconds after the mattress platform reaches the highest position.



## Operating the bed rails

### **Composite Swing Rail**

Raise Bed Rail: Pull the bed rail upwards until the rail is securely locked in place.

Lower Bed Rail: Press the release button, slowly lower the rail to its lowest position.



### **Q-Bar**

Parallel/  
Perpendicular  
Alignment:

Lift up and rotate the bar until it is parallel or perpendicular to the bed edge. Lower the bar and ensure it is securely locked in place.

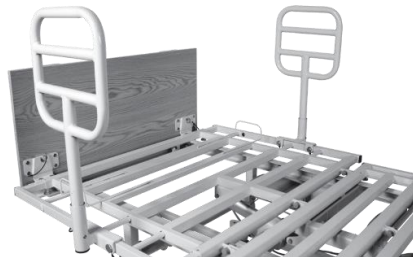

### **Pivot Assist Bar**

Raise Assist Bar: Pull the bar upwards until it is securely locked in place. Ensure the release button is engaged.

Lower Assist Bar: Pull the release knob and slowly lower the bar to its lowest position.



## TROUBLESHOOTING GUIDE

SYMPTOMS	POSSIBLE FAULTS	POSSIBLE SOLUTIONS
Bed idle when hand pendant buttons are pressed.	Adjustment may be at the maximum or minimum position	Check if other buttons are working.
	Power cord not connected or damaged	Ensure the power cord is properly connected to the electrical socket and the bed.
	Hand pendant or actuator connectors are loose	Ensure tight connection of all connectors to control box.
	Load is too heavy	Ensure the load weight is within the designated capacity. Reduce the load.
	Control system requiring a reset	*Reset the electronic system using the hand pendant.
Casters/Brakes noisy or stiff.	Debris or fluff in bearings	Replace casters.
Noisy or dry sound from pivots.	Needs lubrication.	Lubricate your bed.
Unusual noise from actuator.	Actuator is worn or damaged or spindle is bent.	Replace the actuator. Contact your supplier.
Head/footboard unstable.	Head/footboard frame not tightly secured.	Refer to Equipment Assembly

\* Refer to page 17 of this the manual for electronics reset procedures.



If problems persist following the above remedial procedures, please contact your dealer or the manufacturer.

## LIMITED WARRANTY

The Manufacturer warrants to the original user (Customer) all products manufactured by the Manufacturer to be free from defects in material and workmanship under normal use and service for a period as specified below. If such a defect appears and Customer has given immediate written notification of same, the Manufacturer shall replace or repair such part at the Manufacturers option. The Manufacturer will require the return of the defective part to establish the claim. The Manufacturer's obligation under this warranty shall be limited to said replacement and/or repair. Installation and freight costs for replaced or repaired items remain the responsibility of the Customer. This warranty does not cover failure due to negligence, accident, deliberate abuse, nor improper installation and/or maintenance. Modifications made to products (including modifications without the expressed written consent of the Manufacturer) shall void this warranty in its entirety. NO FURTHER WARRANTIES, EXPRESSED OR IMPLIED, INCLUDING, BUT NOT LIMITED TO, WARRANTIES OF MERCHANTABILITY OR FITNESS FOR A PARTICULAR PURPOSE NOT SPECIFIED HEREIN, ARE MADE BY THE MANUFACTURER, AND THIS WARRANTY SETS FORTH THE FULL EXTENT OF THE LIABILITY ARISING FROM THE MANUFACTURE, USE OR SALE OF THE PRODUCTS AND MATERIALS SOLD HEREUNDER. No allowances will be made for delays or loss of profit, nor for any other special, indirect or consequential damages or injuries, whether based on tort or contract.

Applicable warranty periods commencing from date of shipment from ES are as follows:

Welds .....	15 years
Electrical & Mechanical components .....	3 years
All other components .....	1 year

**Emerald Supply Inc  
Brooklyn, NY**

**[www.emeraldsupply.net](http://www.emeraldsupply.net)**



## APPENDIX – SERVICE RECORD

DATE	PERFORMED BY	CONDITION REPORT

DATE	PERFORMED BY	CONDITION REPORT

